

# Spannmuttern, Dichtscheiben und Spannzangen

Clamping nuts, sealing discs and collets



## Katalog Nr. 161 Catalogue No. 161



## Spannmuttern zur Rundlaufoptimierung

- Rundlaufoptimierung über 6 Schrauben
- Reiben ohne Pendleinrichtung möglich
- Erhöhung der Werkzeugstandzeit
- Oberflächenverbesserung
- Gefahrloses Ausrichten auch in der Spindel oder auf dem Werkzeugrevolver
- Spindelrundlauffehler können kompensiert werden

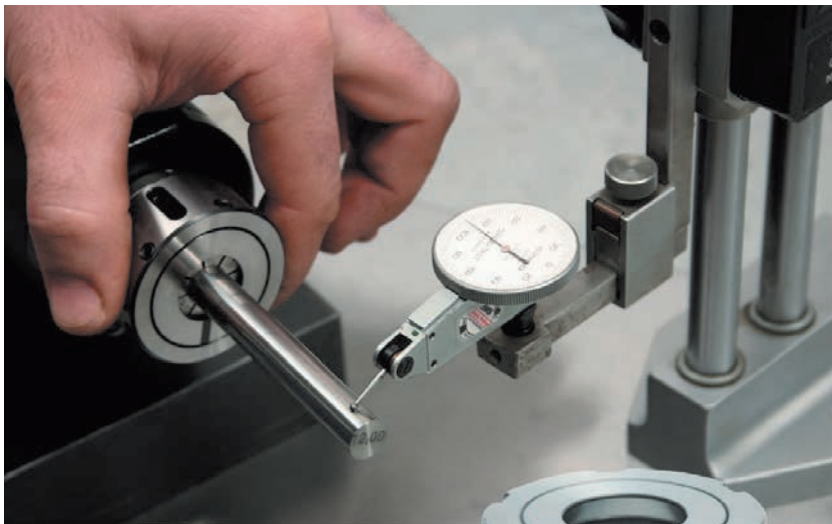

### Bedienungsanleitung

- Verwenden Sie Spannzangen mit einem Spannbereich, keine Hochpräzisionszangen
- Werkzeug mit Nenndurchmesser spannen z.B. Ø 8, Spannzange 8-7 verwenden
- Spannen Sie das Werkzeug wie gewohnt mit der Mutter
- Stellen Sie den Rundlauf über die 6 Innensechskantschrauben am Außendurchmesser der Mutter ein
- Achten Sie darauf, dass alle Schrauben unter Vorspannung stehen
- Bearbeiten Sie Ihr Werkstück ...

### Mit einer einfachen Spannzange den Rundlauf 0 erreichen und das binnen einer Minute.

Die speziell entwickelte Spannmutter mit 6 symmetrisch angeordneten Schrauben am Umfang ermöglichen dies. Die Spannmutter ist zweigeteilt, so dass sich der Innenring minimal verschieben lässt.

Somit lassen sich Toleranzadditionen über diese einfache technische Finesse eliminieren.

Es ist nur die bisherige Spannmutter auszutauschen und schon bewegt sich der Anwender in einer neuen Rundlaufdimension.

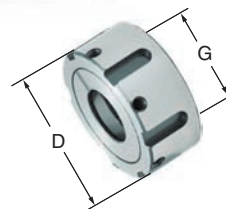

Art.-Nr.	Typ	D	G	Spannschlüssel
716126	RD / ER16 - 426 E	34	M22x1,5	920181
720126	RD / ER20 - 428 E	42	M25x1,5	925180
725126	RD / ER25 - 430 E	50	M32x1,5	932180
732126	RD / ER32 - 470 E	63	M40x1,5	940180
740126	RD / ER40 - 472 E	78	M50x1,5	950180

**Spannmuttern DIN 6499**  
Clamping nuts DIN 6499

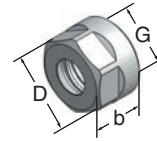

Art.-Nr.	Typ	D	b	G	Spannschlüssel	Nm max.
711120	UMQ / ER11	19	11	M14x0,75	911180	30
716120	UMQ / ER16	28	17	M22x1,50	916180	70

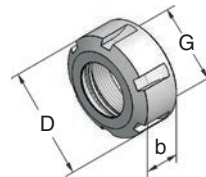

Art.-Nr.	Typ	D	b	G	Spannschlüssel	Nm max.
720120	UMQ / ER20	34	19	M25x1,50	920181	100
725120	UMQ / ER25	42	20	M32x1,50	925180	130
732120	UMQ / ER32	50	22	M40x1,50	932180	170
740120	UMQ / ER40	63	25	M50x1,50	940180	220
750120	UMQ / ER50	78	35	M64x2,00	950180	300

**Spannmuttern DIN 6499 gleitgelagert**  
Clamping nuts DIN 6499 friction bearing

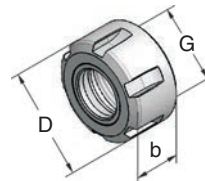
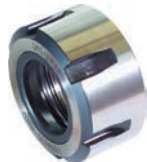

Art.-Nr.	Typ	D	b	G	Spannschlüssel	Nm max.
716123	GMG / ER16	28	18	M22x1,50	916181	70
720123	GMG / ER20	35	20	M25x1,50	920181	100
725123	GMG / ER25	42	20	M32x1,50	925180	130
732123	GMG / ER32	50	23	M40x1,50	932180	170
740123	GMG / ER40	63	26	M50x1,50	940180	220

**Spannschlüssel**  
Key



Art.-Nr.	Typ	für Spannmutter	SW
911180	E 11 P	711120	17
916180	E 16 P	716120	25
920180	E 20 P		30
916181	E 16	716123	
920181	E 20	720120, 720123	
925180	E 25	725120, 725123	
932180	E 32	732120, 732123	
940180	E 40	740120, 740123	
950180	E 50	750120	

**Spannmuttern DIN 6499 mini**  
Clamping nuts DIN 6499 mini

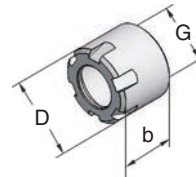

Art.-Nr.	Typ	D	b	G	Spannschlüssel	Nm max.
908100	ER 8M	12	11	M10x0,75	908160	6
911100	ER11M	16	11	M13x0,75	911160	20
916100	ER16M	22	17	M19x1,00	916160	30
920100	ER20M	28	19	M24x1,00	920160	35
925100	ER25M	35	20	M30x1,00	925160	40

**Spannschlüssel mini**  
Key mini



Art.-Nr.	Typ	für Spannmutter
908160	E 8 mini	908100
911160	E 11 mini	911100
916160	E 16 mini	916100
920160	E 20 mini	920100
925160	E 25 mini	925100

**Spannmuttern DIN 6499 mini**  
Clamping nuts DIN 6499 mini

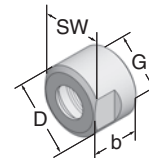

Art.-Nr.	Typ	D	b	G	SW	Nm max.
716120-2	ER16	25	17,5	M20x1,00	22	30
916162	Spannschlüssel ER16				22	

**Spannmuttern ETS**  
Clamping nuts ETS

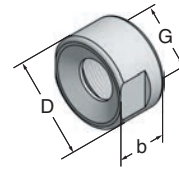

Art.-Nr.	Typ	D	b	G	Spannschlüssel	Nm max.
709130	ETS 9	13,5	8	M10x0,75	762101	10
712130	ETS12	19	12	M14x0,75	912163	10
716120-2ETS	ETS16	27	15	M20x1,00	916163	30

**Spannschlüssel**  
Key



Art.-Nr.	Typ	für Spannmutter
762101	Spannschlüssel ETS 9	709130
912163	Spannschlüssel ETS12	712130
916163	Spannschlüssel ETS16	716120-2ETS

**Spannmuttern ETS**  
Clamping nuts ETS

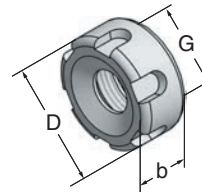

Art.-Nr.	Typ	D	b	G	Spannschlüssel	Nm max.
716130	ETS16	32	15	M22x1,50	916181	30
720130	ETS20	35	16,5	M25x1,50	920181	30
725130	ETS25	42	18,5	M32x1,50	925180	120
732130	ETS32	50	22	M40x1,50	932180	150
740130	ETS40	63	25	M50x1,50	940180	200

**Spannschlüssel**  
Key



Art.-Nr.	Typ	für Spannmutter
916181	E 16	716130
920181	E 20	720130
925180	E 25	725130
932180	E 32	732130
940180	E 40	740130

**Spannmuttern DIN 6499 gleitgelagert für Dichtscheiben**  
Clamping nuts DIN 6499 friction bearing for sealing discs

Lieferumfang ohne Dichtscheibe  
Delivery without sealing disc

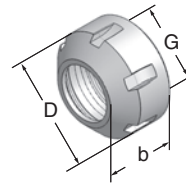

Art.-Nr.	Typ	D	b	G	Nm max.	Dichtscheibe
716124	GMGC / ER16	28	23	M22x1,5	70	excl. DS / ER16
720124	GMGC / ER20	34	25	M25x1,5	100	excl. DS / ER20
725124	GMGC / ER25	42	26	M32x1,5	130	excl. DS / ER25
732124	GMGC / ER32	50	28	M40x1,5	170	excl. DS / ER32
740124	GMGC / ER40	63	31	M50x1,5	220	excl. DS / ER40

**Spannschlüssel**  
Key



Art.-Nr.	Typ	für Spannmutter
916181	E 16	716124
920181	E 20	720124
925180	E 25	725124
932180	E 32	732124
940180	E 40	740124

**Spannmuttern DIN 6499 mini für Dichtscheiben**  
Clamping nuts DIN 6499 for sealing discs

Lieferumfang ohne Dichtscheibe  
Delivery without sealing disc

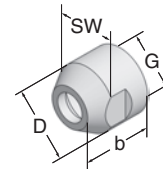

Art.-Nr.	Typ	D	b	G	SW	Nm max.
716124-2	ER16C mini	25	22	M20x1,0	22	30
excl. Dichtscheibe/Sealing disc DS / ER16						
916162	Spannschlüssel ER16				22	

**Spannmuttern ETS mini für Dichtscheiben**  
Clamping nuts ETS mini for sealing disc

Lieferumfang ohne Dichtscheibe  
Delivery without sealing disc

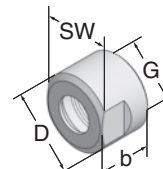

Art.-Nr.	Typ	D	b	G	SW	Nm max.
716124-2ETS	ETS16C	27	22,5	M20x1,00	24	30
excl. Dichtscheibe/Sealing disc DS / ER16						
916163	Spannschlüssel ETS16				24	

**Spannmuttern DIN 6388 Ortlieb für Dichtscheiben**

Clamping nuts DIN 6388 Ortlieb for sealing discs

Lieferumfang ohne Dichtscheibe  
Delivery without sealing disc

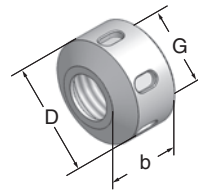

Art.-Nr.	Typ	D	b	G	Nm max.	Dichtscheibe
816124	OZC16	43	29	M33x1,5	130	DS / ER25
825124	OZC25	60	35	M48x2,0	200	DS / OZ25
832124	OZC32	72	38	M60x2,5	220	DS / ER40

**Hakenschlüssel für Ortlieb-Spannmuttern DIN 6388**

Hook spanners for Ortlieb-nuts DIN 6388

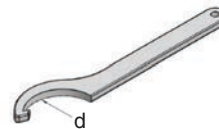

Art.-Nr.	d	für Spannmutter
54635	40 - 42	816124
54668	58 - 65	825124
54676	68 - 75	832124

**Spannmuttern DIN 6499 / DIN 6388 zum Auswuchten**

incl. 2 Wuchtgewichten Art.- Nr. 600101

Clamping nuts DIN 6499 / DIN 6388 for balancing  
incl. 2 balancing weights Art.- Nr. 600101

Lieferumfang ohne Spannzange und Werkzeug  
Delivery without collet and tool

Spannzangenfutter in ausgewuchteter Ausführung garantieren zusammen mit dem gespannten Werkzeug nicht unbedingt die gewünschte Wuchtqualität für die Zerspanung im hohen Drehzahlbereich. Die neuen Spannmutter-Typen ermöglichen nach der Spannung des Werkzeuges die Auswuchtung als komplette Einheit.

Collet chucks in a balanced execution together with the clamped tools cannot absolutely guarantee the balance quality as desired for the cutting process in a high revolution speed range. The newly developed collet nut types allow the balancing as a complete unit after the clamping of the tool.

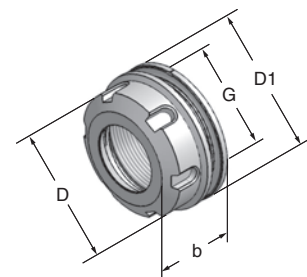

Art.-Nr.	Typ	D	D1	b	G	Spannschlüssel	Nm max.
725120-B	ER25	42	46	24	M32x1,5	925180	130
732120-B	ER32	50	54	25	M40x1,5	932180	170
740120-B	ER40	63	64	27	M50x1,5	940180	220
825120-B	OZ25	63	63	30	M48x2,0	54668	200

**Spannschlüssel**

Key



Art.-Nr.	Typ	für Spannmutter
925180	E 25	725120-B
932180	E 32	732120-B
940180	E 40	740120-B
54668	Hakenschlüssel	825120-B

**Dichtscheiben für Spannmuttern DIN 6499, DIN 6388 & ETS  
für Werkzeuge mit interner Kühlmittelzufuhr**

Sealing discs for clamping nuts DIN 6499, DIN 6388 & ETS  
for tools with internal coolant supply

Kühlmitteldruck / Coolant pressure min. 5 bar - max. 100 bar



Der eingelegte O-Ring gewährleistet interne Kühlmittelzufuhr durch das gespannte Werkzeug direkt zur Werkzeugschneide

The inserted O-ring seal ensures a coolant supply internally through the clamped tool directly to the cutting edge

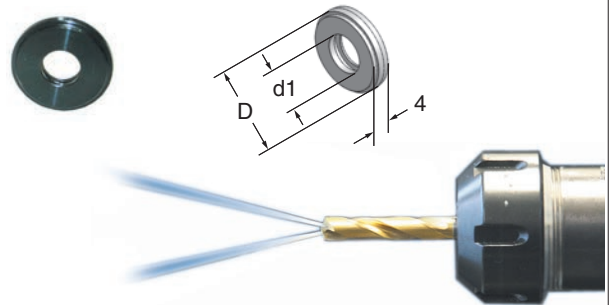

**Dichtscheiben für Spannmuttern  
Ortlieb DIN 6388  
für Werkzeuge mit interner  
Kühlmittelzufuhr**

Sealing discs for clamping nuts  
Ortlieb DIN 6388  
for tools with internal coolant supply

Art.-Nr. Typ D d1

Art.-Nr.	Typ	D	d1	Art.-Nr.	Typ	D	d1	Art.-Nr.	Typ	D	d1
316040	DS/ER16	13	ø4 - 3	332040	DS/ER32	27	ø4 - 3	350050	DS/OZ25	31	ø5 - 4
316050	DS/ER16	13	ø5 - 4	332050	DS/ER32	27	ø5 - 4	350060	DS/OZ25	31	ø6 - 5
316060	DS/ER16	13	ø6 - 5	332060	DS/ER32	27	ø6 - 5	350070	DS/OZ25	31	ø7 - 6
316070	DS/ER16	13	ø7 - 6	332070	DS/ER32	27	ø7 - 6	350080	DS/OZ25	31	ø8 - 7
316080	DS/ER16	13	ø8 - 7	332080	DS/ER32	27	ø8 - 7	350090	DS/OZ25	31	ø9 - 8
316090	DS/ER16	13	ø9 - 8	332090	DS/ER32	27	ø9 - 8	350100	DS/OZ25	31	ø10 - 9
316100	DS/ER16	13	ø10 - 9	332100	DS/ER32	27	ø10 - 9	350110	DS/OZ25	31	ø11 - 10
				332110	DS/ER32	27	ø11-10	350120	DS/OZ25	31	ø12-11
320040	DS/ER20	16	ø4 - 3	332120	DS/ER32	27	ø12-11	350130	DS/OZ25	31	ø13-12
320050	DS/ER20	16	ø5 - 4	332130	DS/ER32	27	ø13-12	350140	DS/OZ25	31	ø14-13
320060	DS/ER20	16	ø6 - 5	332140	DS/ER32	27	ø14-13	350150	DS/OZ25	31	ø15-14
320070	DS/ER20	16	ø7 - 6	332150	DS/ER32	27	ø15-14	350160	DS/OZ25	31	ø16-15
320080	DS/ER20	16	ø8 - 7	332160	DS/ER32	27	ø16-15	350170	DS/OZ25	31	ø17-16
320090	DS/ER20	16	ø9 - 8	332170	DS/ER32	27	ø17-16	350180	DS/OZ25	31	ø18-17
320100	DS/ER20	16	ø10 - 9	332180	DS/ER32	27	ø18-17	350190	DS/OZ25	31	ø19-18
320110	DS/ER20	16	ø11-10	332190	DS/ER32	27	ø19-18	350200	DS/OZ25	31	ø20-19
320120	DS/ER20	16	ø12-11	332200	DS/ER32	27	ø20-19	350210	DS/OZ25	31	ø21-20
320130	DS/ER20	16	ø13-12					350220	DS/OZ25	31	ø22-21
				340050	DS/ER40	33,5	ø5 - 4	350230	DS/OZ25	31	ø23-22
325040	DS/ER25	21	ø4 - 3	340060	DS/ER40	33,5	ø6 - 5	350240	DS/OZ25	31	ø24-23
325050	DS/ER25	21	ø5 - 4	340070	DS/ER40	33,5	ø7 - 6	350250	DS/OZ25	31	ø25-24
325060	DS/ER25	21	ø6 - 5	340080	DS/ER40	33,5	ø8 - 7				
325070	DS/ER25	21	ø7 - 6	340090	DS/ER40	33,5	ø9 - 8				
325080	DS/ER25	21	ø8 - 7	340100	DS/ER40	33,5	ø10 - 9				
325090	DS/ER25	21	ø9 - 8	340110	DS/ER40	33,5	ø11-10				
325100	DS/ER25	21	ø10 - 9	340120	DS/ER40	33,5	ø12-11				
325110	DS/ER25	21	ø11-10	340130	DS/ER40	33,5	ø13-12				
325120	DS/ER25	21	ø12-11	340140	DS/ER40	33,5	ø14-13				
325130	DS/ER25	21	ø13-12	340150	DS/ER40	33,5	ø15-14				
325140	DS/ER25	21	ø14-13	340160	DS/ER40	33,5	ø16-15				
325150	DS/ER25	21	ø15-14	340170	DS/ER40	33,5	ø17-16				
325160	DS/ER25	21	ø16-15	340180	DS/ER40	33,5	ø18-17				
				340190	DS/ER40	33,5	ø19-18				
				340200	DS/ER40	33,5	ø20-19				
				340210	DS/ER40	33,5	ø21-20				
				340220	DS/ER40	33,5	ø22-21				
				340230	DS/ER40	33,5	ø23-22				
				340240	DS/ER40	33,5	ø24-23				
				340250	DS/ER40	33,5	ø25-24				
				340260	DS/ER40	33,5	ø26-25				



**Spannzangen ER/ESX DIN 6499-B rego-fix**

Collets type ER/ESX DIN 6499-B rego-fix

Sätze 111001. 116001. 120001.  
125001. 132001. 140001.  
nicht Original rego-fix



ER 8		ER 11/424 E		ER 16/426 E		ER 20/428 E	
Art.-Nr.	Spannbereich	Art.-Nr.	Spannbereich	Art.-Nr.	Spannbereich	Art.-Nr.	Spannbereich
108001	Satz / Set	111001	Satz / Set	116001	Satz / Set	120001	Satz / Set
		111002	Satz / Set	116002	Satz / Set	120002	Satz / Set
9 Stück/pcs. ø1-ø5		13 Stück/pcs. ø1-ø7		10 Stück/pcs. ø1-ø10		12 Stück/pcs. ø2-ø13	
108010	ø1,0 - 0,5	111010	ø1,0 - 0,5	116010	ø1,0 - 0,5	120010	ø1,0 - 0,5
108015	ø1,5 - 1,0	111015	ø1,5 - 1,0	116020	ø2,0 - 1,0	120020	ø2,0 - 1,0
108020	ø2,0 - 1,5	111020	ø2,0 - 1,5	116030	ø3,0 - 2,0	120030	ø3,0 - 2,0
108025	ø2,5 - 2,0	111025	ø2,5 - 2,0	116040	ø4,0 - 3,0	120040	ø4,0 - 3,0
108030	ø3,0 - 2,5	111030	ø3,0 - 2,5	116050	ø5,0 - 4,0	120050	ø5,0 - 4,0
108035	ø3,5 - 3,0	111035	ø3,5 - 3,0	116060	ø6,0 - 5,0	120060	ø6,0 - 5,0
108040	ø4,0 - 3,5	111040	ø4,0 - 3,5	116070	ø7,0 - 6,0	120070	ø7,0 - 6,0
108045	ø4,5 - 4,0	111045	ø4,5 - 4,0	116080	ø8,0 - 7,0	120080	ø8,0 - 7,0
108050	ø5,0 - 4,5	111050	ø5,0 - 4,5	116090	ø9,0 - 8,0	120090	ø9,0 - 8,0
		111055	ø5,5 - 5,0	116100	ø10,0 - 9,0	120100	ø10,0 - 9,0
		111060	ø6,0 - 5,5	ER 40/472 E		120110	ø11,0 - 10,0
		111065	ø6,5 - 6,0	140001	Satz / Set	120120	ø12,0 - 11,0
		111070	ø7,0 - 6,5	140002	Satz / Set	120130	ø13,0 - 12,0
ER 25/430 E		ER 32/470 E		23 Stück/pcs. ø3-ø26		ER 50/474 E	
125001	Satz / Set	132001	Satz / Set	140030	ø3,0 - 2,0	150001	Satz / Set
125002	Satz / Set	132002	Satz / Set	140040	ø4,0 - 3,0	2 Stück/pcs. ø10-ø34	
15 Stück/pcs. ø2-ø16		18 Stück/pcs. ø2-ø20		140050	ø6,0 - 5,0	150060	ø6,0 - 5,0
125010	ø1,0 - 0,5			140060	ø6,0 - 5,0	150080	ø8,0 - 6,0
125020	ø2,0 - 1,0	132020	ø2,0 - 1,0	140070	ø7,0 - 6,0	150100S	ø10,0 - 8,0
125030	ø3,0 - 2,0	132030	ø3,0 - 2,0	140080	ø8,0 - 7,0	150120	ø12,0 - 10,0
125040	ø4,0 - 3,0	132040	ø4,0 - 3,0	140090	ø9,0 - 8,0	150140	ø14,0 - 12,0
125050	ø5,0 - 4,0	132050	ø5,0 - 4,0	140100	ø10,0 - 9,0	150160	ø16,0 - 14,0
125060	ø6,0 - 5,0	132060	ø6,0 - 5,0	140110	ø11,0 - 10,0	150180	ø18,0 - 16,0
125070	ø7,0 - 6,0	132070	ø7,0 - 6,0	140120	ø12,0 - 11,0	150200	ø20,0 - 18,0
125080	ø8,0 - 7,0	132080	ø8,0 - 7,0	140130	ø13,0 - 12,0	150220	ø22,0 - 20,0
125090	ø9,0 - 8,0	132090	ø9,0 - 8,0	140140	ø14,0 - 13,0	150240	ø24,0 - 22,0
125100	ø10,0 - 9,0	132100	ø10,0 - 9,0	140150	ø15,0 - 14,0	150250	ø25,0 - 23,0
125110	ø11,0 - 10,0	132110	ø11,0 - 10,0	140160	ø16,0 - 15,0	150260	ø26,0 - 24,0
125120	ø12,0 - 11,0	132120	ø12,0 - 11,0	140170	ø17,0 - 16,0	150280	ø28,0 - 26,0
125130	ø13,0 - 12,0	132130	ø13,0 - 12,0	140180	ø18,0 - 17,0	150300	ø30,0 - 28,0
125140	ø14,0 - 13,0	132140	ø14,0 - 13,0	140190	ø19,0 - 18,0	150320	ø32,0 - 30,0
125150	ø15,0 - 14,0	132150	ø15,0 - 14,0	140200	ø20,0 - 19,0	150340	ø34,0 - 32,0
125160	ø16,0 - 15,0	132160	ø16,0 - 15,0	140210	ø21,0 - 20,0		
		132170	ø17,0 - 16,0	140220	ø22,0 - 21,0		
		132180	ø18,0 - 17,0	140230	ø23,0 - 22,0		
		132190	ø19,0 - 18,0	140240	ø24,0 - 23,0		
		132200	ø20,0 - 19,0	140250	ø25,0 - 24,0		
				140260	ø26,0 - 25,0		
				140270	ø27,0 - 26,0		
				140280	ø28,0 - 27,0		
				140290	ø29,0 - 28,0		
				140300	ø30,0 - 29,0		

**Spannzangen DIN 6499 abgedichtet**  
für Werkzeuge mit Innenkühlung

**Nur Nennmaßspannung**

**Collets DIN 6499**

for tools with inner cooling systems

**Only for nominal diameter**

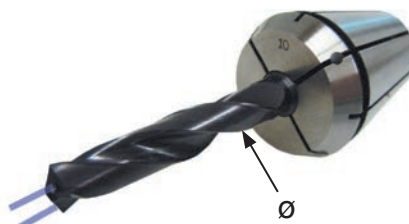

ER 16 C		ER 20 C		ER 25 C		ER 32 C	
Art.-Nr.	Spannbereich	Art.-Nr.	Spannbereich	Art.-Nr.	Spannbereich	Art.-Nr.	Spannbereich
116001C	Satz / Set	120001C	Satz / Set	125001C	Satz / Set	132001C	Satz / Set
8 Stück/pcs. ø3-ø10		10 Stück/pcs. ø4-ø13		13 Stück/pcs. ø4-ø16		17 Stück/pcs. ø4-ø20	
116030C	ø3,0	120030C	ø3,0	125030C	ø3,0	132030C	ø3,0
116040C	ø4,0	120040C	ø4,0	125040C	ø4,0	132040C	ø4,0
116050C	ø5,0	120050C	ø5,0	125050C	ø5,0	132050C	ø5,0
116060C	ø6,0	120060C	ø6,0	125060C	ø6,0	132060C	ø6,0
116070C	ø7,0	120070C	ø7,0	125070C	ø7,0	132070C	ø7,0
116080C	ø8,0	120080C	ø8,0	125080C	ø8,0	132080C	ø8,0
116090C	ø9,0	120090C	ø9,0	125090C	ø9,0	132090C	ø9,0
116100C	ø10,0	120100C	ø10,0	125100C	ø10,0	132100C	ø10,0
		120110C	ø11,0	125110C	ø11,0	132110C	ø11,0
		120120C	ø12,0	125120C	ø12,0	132120C	ø12,0
		120130C	ø13,0	125130C	ø13,0	132130C	ø13,0
ER 40 C		ER 50 C		125140C	ø14,0	132140C	ø14,0
140001C	Satz / Set	150001C	Satz / Set	125150C	ø15,0	132150C	ø15,0
23 Stück/pcs. ø4-ø26		7 Stück/pcs. ø8-ø32*		125160C	ø16,0	132160C	ø16,0
140040C	ø4,0	150120C	ø12,0			132170C	ø17,0
140050C	ø5,0	150130C	ø13,0			132180C	ø18,0
140060C	ø6,0	150140C	ø14,0			132190C	ø19,0
140070C	ø7,0	150150C	ø15,0			132200C	ø20,0
140080C	ø8,0	150160C	ø16,0				
140090C	ø9,0	150170C	ø17,0				
140100C	ø10,0	150180C	ø18,0				
140110C	ø11,0	150190C	ø19,0				
140120C	ø12,0	150200C	ø20,0				
140130C	ø13,0	150210C	ø21,0				
140140C	ø14,0	150220C	ø22,0				
140150C	ø15,0	150230C	ø23,0				
140160C	ø16,0	150240C	ø24,0				
140170C	ø17,0	150250C	ø25,0				
140180C	ø18,0	150260C	ø26,0				
140190C	ø19,0	150270C	ø27,0				
140200C	ø20,0	150280C	ø28,0				
140210C	ø21,0	150290C	ø29,0				
140220C	ø22,0	150300C	ø30,0				
140230C	ø23,0	150310C	ø31,0				
140240C	ø24,0	150320C	ø32,0				
140250C	ø25,0	150330C	ø33,0				
140260C	ø26,0	150340C	ø34,0				
		* ø8, 10, 12, 16, 20, 25, 32					

**Gewindebohrzangen rego-fix**  
Tapping collets rego-fix



ER 16-GB		ER 25-GB		ER 32-GB		ER 40-GB	
Art.-Nr.	Schaft $\varnothing \times \square$	Art.-Nr.	Schaft $\varnothing \times \square$	Art.-Nr.	Schaft $\varnothing \times \square$	Art.-Nr.	Schaft $\varnothing \times \square$
GB116045	$\varnothing 4,5 \times 3,4$	GB125045	$\varnothing 4,5 \times 3,4$	GB132045	$\varnothing 4,5 \times 3,4$	GB140070	$\varnothing 7,0 \times 5,5$
GB116055	$\varnothing 5,5 \times 4,3$	GB125055	$\varnothing 5,5 \times 4,3$	GB132055	$\varnothing 5,5 \times 4,3$	GB140080	$\varnothing 8,0 \times 6,2$
GB116060	$\varnothing 6,0 \times 4,9$	GB125060	$\varnothing 6,0 \times 4,9$	GB132060	$\varnothing 6,0 \times 4,9$	GB140090	$\varnothing 9,0 \times 7,0$
GB116070	$\varnothing 7,0 \times 5,5$	GB125070	$\varnothing 7,0 \times 5,5$	GB132070	$\varnothing 7,0 \times 5,5$	GB140100	$\varnothing 10,0 \times 8,0$
	<b>ER 20-GB</b>	GB125080	$\varnothing 8,0 \times 6,2$	GB132080	$\varnothing 8,0 \times 6,2$	GB140110	$\varnothing 11,0 \times 9,0$
GB120045	$\varnothing 4,5 \times 3,4$	GB125090	$\varnothing 9,0 \times 7,0$	GB132090	$\varnothing 9,0 \times 7,0$	GB140120	$\varnothing 12,0 \times 9,0$
GB120055	$\varnothing 5,5 \times 4,3$	GB125100	$\varnothing 10,0 \times 8,0$	GB132100	$\varnothing 10,0 \times 8,0$	GB140140	$\varnothing 14,0 \times 11,0$
GB120060	$\varnothing 6,0 \times 4,9$	GB125110	$\varnothing 11,0 \times 9,0$	GB132110	$\varnothing 11,0 \times 9,0$	GB140160	$\varnothing 16,0 \times 12,0$
GB120070	$\varnothing 7,0 \times 5,5$	GB125120	$\varnothing 12,0 \times 9,0$	GB132120	$\varnothing 12,0 \times 9,0$	GB140180	$\varnothing 18,0 \times 14,5$
GB120080	$\varnothing 8,0 \times 6,2$			GB132140	$\varnothing 14,0 \times 11,0$	GB140200	$\varnothing 20,0 \times 16,0$
GB120090	$\varnothing 9,0 \times 7,0$			GB132160	$\varnothing 16,0 \times 12,0$	GB140220	$\varnothing 22,0 \times 18,0$
GB120100	$\varnothing 10,0 \times 8,0$						

**Gewindebohrzangen PCM ET1 mit Längenausgleich**  
Tapping collets PCM ET1 with compensation



ET1-16		ET1-20		ET1-25		ET1-32		ET1-40	
Art.-Nr.	Schaft	Art.-Nr.	Schaft	Art.-Nr.	Schaft	Art.-Nr.	Schaft	Art.-Nr.	Schaft
ET1-16280	$\varnothing 2,8$	ET1-20280	$\varnothing 2,8$	ET1-25280	$\varnothing 2,8$	ET1-32450	$\varnothing 4,5$	ET1-40600	$\varnothing 6,0$
ET1-16300	$\varnothing 3,0$	ET1-20300	$\varnothing 3,0$	ET1-25300	$\varnothing 3,0$	ET1-32500	$\varnothing 5,0$	ET1-40700	$\varnothing 7,0$
ET1-16350	$\varnothing 3,5$	ET1-20350	$\varnothing 3,5$	ET1-25350	$\varnothing 3,5$	ET1-32550	$\varnothing 5,5$	ET1-40800	$\varnothing 8,0$
ET1-16400	$\varnothing 4,0$	ET1-20400	$\varnothing 4,0$	ET1-25400	$\varnothing 4,0$	ET1-32600	$\varnothing 6,0$	ET1-40850	$\varnothing 8,5$
ET1-16450	$\varnothing 4,5$	ET1-20450	$\varnothing 4,5$	ET1-25450	$\varnothing 4,5$	ET1-32700	$\varnothing 7,0$	ET1-40900	$\varnothing 9,0$
ET1-16500	$\varnothing 5,0$	ET1-20500	$\varnothing 5,0$	ET1-25500	$\varnothing 5,0$	ET1-32800	$\varnothing 8,0$	ET1-40100	$\varnothing 10,0$
ET1-16550	$\varnothing 5,5$	ET1-20550	$\varnothing 5,5$	ET1-25550	$\varnothing 5,5$	ET1-32850	$\varnothing 8,5$	ET1-40105	$\varnothing 10,5$
ET1-16600	$\varnothing 6,0$	ET1-20600	$\varnothing 6,0$	ET1-25600	$\varnothing 6,0$	ET1-32900	$\varnothing 9,0$	ET1-40110	$\varnothing 11,0$
		ET1-20700	$\varnothing 7,0$	ET1-25700	$\varnothing 7,0$	ET1-32100	$\varnothing 10,0$	ET1-40120	$\varnothing 12,0$
				ET1-25800	$\varnothing 8,0$	ET1-32105	$\varnothing 10,5$	ET1-40125	$\varnothing 12,5$
				ET1-25850	$\varnothing 8,5$	ET1-32110	$\varnothing 11,0$	ET1-40140	$\varnothing 14,0$
				ET1-25900	$\varnothing 9,0$	ET1-32120	$\varnothing 12,0$	ET1-40150	$\varnothing 15,0$
				ET1-25100	$\varnothing 10,0$	ET1-32125	$\varnothing 12,5$	ET1-40160	$\varnothing 16,0$
								ET1-40170	$\varnothing 17,0$

Allgemeine Verkaufsbedingungen finden Sie auf unserer Website:

Visit our website for General Condition of Sales:

[www.zuern-tools.de/agb](http://www.zuern-tools.de/agb)



**zürn**

# Spannmuttern, Dichtscheiben und Spannzangen

Clamping nuts, sealing discs and collets

